

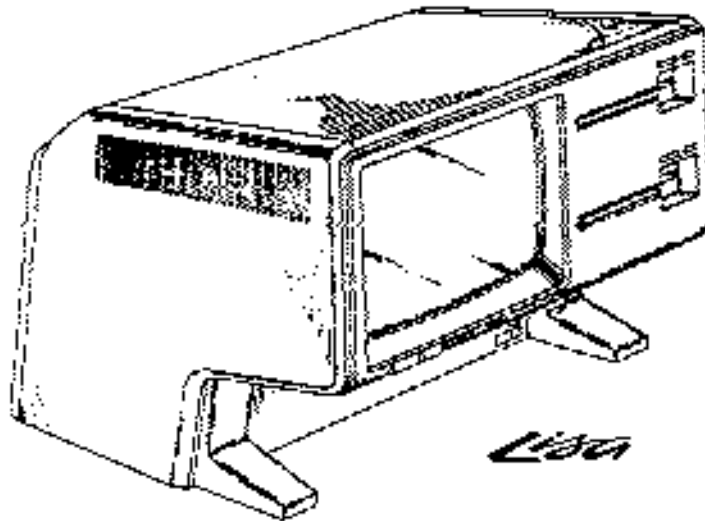

Apple Lisa/Macintosh XL Do-it-Yourself Guide

Published by Sun Remarketing, Inc. around 1990.



Note:

Portions of this seem to be copied from Larry Pina's "Macintosh Repair and Upgrade Secrets", but no credit is given in this document.



Lisa

Computer Repair Information

Table of Contents

Identifying the Models

Lisa/XL Disassembly Procedure

Automatic Startup Test

Lisa/Mac XL Test Diskette

Built-in Service Mode

Mechanical Problems with the 3.5 Inch Disk Drive

Hard Drive Repairs

MacWorks Plus

800K Disk Drive Upgrade

Expansion Card Upgrades

Internal Hard Drive Upgrades

Memory Upgrades

Video Upgrades-External Monitors

Video Upgrades-Internal Monitor-Macintosh XL Screen Kit

Summary

Appendix A-General Troubleshooting



Many people believe that Lisas and Macintosh XL's are exactly the same computer. In truth, Lisas and XL's only look the same. There are two different models in the series. The Macintosh XL (a.k.a. Lisa 2/10) is the newest model. Since there are differences between the models, it's important to determine which Lisa/Mac XL you own before beginning any upgrade or repair work.

Identifying the Models

This section lists the official hardware configurations. Hardware means a specific combination of drives, boards, and so on. By identifying what hardware is inside the box, you can easily determine which model of the Lisa you own. Table 1 provides a checklist. The next section provides illustrated disassembly instructions so that you can match your particular hardware configuration against the list.

Lisa 2: The Lisa 2 has one 3.5-inch 400K disk drive, different disk drive controller circuitry, and a redesigned front panel to accommodate the single 3.5-inch drive opening. A 400K floppy controller, labeled the "Lisa Lite Adapter," is mounted inside the disk drive cage. The System I/O board is socketed for an AMD 9512 arithmetic processor. It has nickel-cadmium battery backup for the real time clock. One 512K memory board is standard. The mother board has a mouse connector, two serial connectors, and an external parallel connector. The power supply is rated 1.2 A.

Lisa 2/10: The Lisa 2/10 has a completely different motherboard. The mouse connector is different. There's no external parallel connector on the back of the computer. Instead, there's an internal parallel connector and a 10MB internal I hard drive. An interrupt switch has been added. The system I/O board is also different. There's no socket for the AMD 9512 coprocessor. There's no nickel-cadmium battery backup for the real time clock. The disk drive controller is different. An extra chip on the I/O board replaces the Lisa Lite Adapter which was formerly located in the drive cage. The disk drive cabling is different. The wiring harness is different. The power supply is different. One megabyte of RAM is standard. If you have Lisa OS disks, a 10MB internal hard drive, no Lisa Lite card, no external parallel connector, and a 1.8-A 110/220V power supply, yours is at least a Lisa 2/10.

Macintosh XL: The Macintosh XL is exactly the same as a Lisa 2/10. Only the sticker on the box, the operating system, and the instruction manuals are different. Instead of Lisa OS, the bundled OS is Macintosh System software and MacWorks XL, a Lisa program which allows 64K Macintosh ROM emulation. If you have MacWorks XL instead of Lisa OS disks, a 10MB internal hard drive, no Lisa Lite card, and a 1.8-A power supply, yours is probably a Macintosh XL.

Regardless of which model you own, all Lisa/XL's are easily repaired. The next two sections show how to get a dead Lisa going again. The section after that shows how to turn it into a super deluxe, big-screen Macintosh Plus.



Table 1 Hardware Configuration Checklist

This sample table reflects a fully upgraded Lisa 2/5

Item	Check	Model#/Notes
400K internal floppy		
800K internal floppy	✓	Sony# MPF-51W
Lite adapter	✓	Apple# 620-149
Internal hard drive	✓	Sun 20MB SCSI
1.2-A power supply		
1.8-A power supply	✓	Jumpered for 110 V AC
System I/O board	✓	Apple# 620-0117 (Lisa 2/5)
CPU board	✓	Apple# 620-0119
Memory 1 board	✓	Apple# 620-0112 (512K)
Memory 2 board	✓	Apple# 620-0112 (512K)
Screen kit transformer	✓	Properly installed
ROM version	✓	3A/A8 (XL screen kit)



Lisa/XL Disassembly Procedure

All Lisa/XL models are built on the same chassis and come apart the same way, without tools. Before beginning, shut down the Lisa (if it's on) and physically disconnect the power cord from the back of the computer. To remove the front panel place your hands along the bottom edge, feel for the two finger grips, and push up gently as shown in Figure 1. Pushing up disengages two plastic tabs, swings the front panel forward, and opens a safety switch in the lower left corner of the chassis. If the computer is on, removing the front panel will immediately turn it off. Since this is not the recommended way to power down, always remember to Save your work and Shut Down before removing the panel.

The disk-drive assembly is held in place by a spring-loaded knurled nut as shown in Figure 2. To remove the entire disk-drive cage, loosen the nut until it springs free and then pull straight back. The cage slips out easily. Normally, the wiring harness is just long enough to allow you to set the assembly down in front of the computer. Take care not to snag or overextend the drive cables. As shown in Figure 3, there's not much slack!



Figure 1

To remove the front panel, feel for the finger grips at the bottom edge and push up gently.

Once the drive cage is out, note whether the floppy drive ribbon cable is routed to a connector at the back of the cage or whether it's connected to a Lisa Lite Adapter mounted in the lower left-rear portion of the drive cage. A Lite Adapter indicates that the computer is a Lisa 2. Direct connection suggests a Mac XL. You can remove the internal disk drive by tilting the drive cage forward and loosening four screws at the bottom. Hard drives, when present, are held by five or six screws along the side.



Figure 2

To remove the entire disk drive cage, loosen this retaining nut until it springs free and then pull straight back.

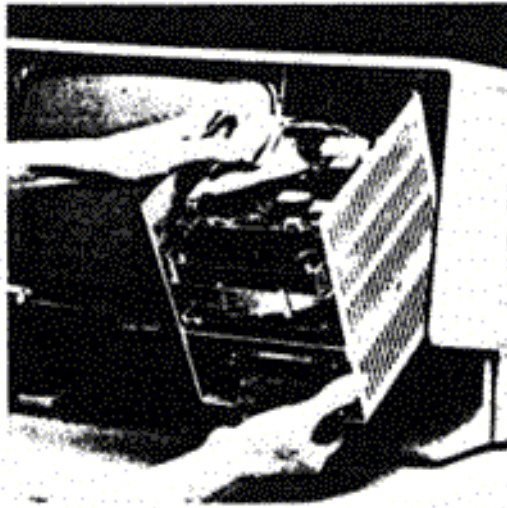

Figure 3

When removing the disk drive assembly take care not to snag or overextend the drive cables. There's not much slack!

400K Sony drives are identified by part numbers beginning with OAD34V. 800K Sony drives are identified by part numbers beginning with MPF51 W. You might also find an 800K Chinnon or Fujitsu drive in a Lisa. Original 10MB Widget drives are marked "Apple computer." Other internal hard drives might be marked "Fujitsu," "Kalok," "Miniscribe," or "Seagate", etc. For reference, write down the make and model numbers of whatever drives you find.



The rear panel is held on by two thumbscrews. Turning the thumbscrew counterclockwise disengages a metal retaining tab. Note that it's not necessary to remove the thumbscrews. With a little loosening, you can pull the rear panel back and lift it away. This procedure is shown in Fig. 4.

Removing the rear panel opens a second safety switch in the upper right-hand corner of the computer located on the power supply. If the computer is on, removing the rear panel also turns it off. Safety switches protect the computer as well as the operator. It's possible to defeat safety switches (the cap of a ball point pen works well) but be careful. Removing cards without turning the power off first is a surefire way to destroy them.

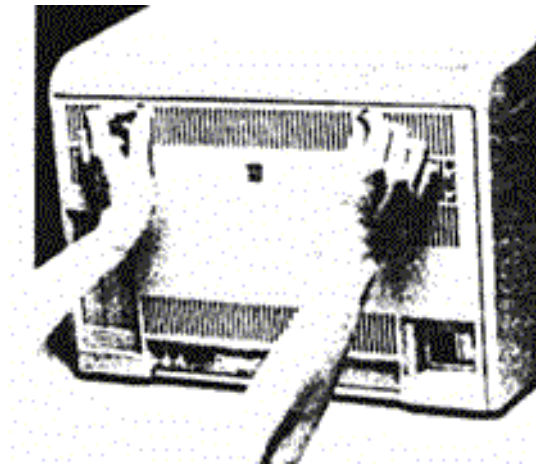

Figure 4

To remove the rear panel, first disconnect the power cord and all peripheral cables, then turn the thumbscrews counterclockwise, pull slightly, and lift at an angle.

Note that pressing the on/off switch or removing the covers (engaging the safety switches) does not remove all power to the computer. The only way power can be completely removed is by unplugging the line cord.

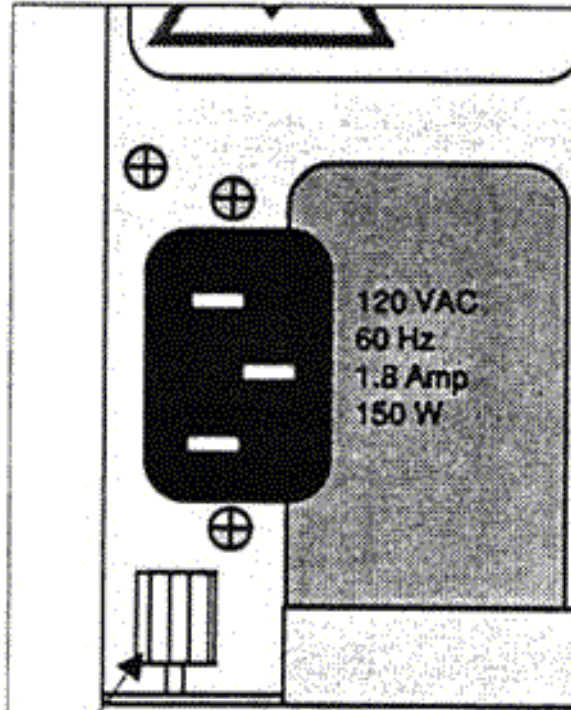

Figure 5

To remove the power supply, loosen the finger nut and pull straight back. Note that the nut is located approximately 1/2 inch from the edge of the chassis.

The power supply is attached by a second spring loaded, knurled nut as shown in Figure 5. Once you loosen the nut it may take considerable force to remove the supply. This is normal because of a tight fitting tongue and socket connector. If the connector fits loosely, the operating voltages might fluctuate and the computer would be subject to intermittent operation.

Fortunately, it's very well made. When you need to remove the power supply, loosen the finger nut (until it springs free) and pull straight back. When you need to replace the power supply, push it in 1/4 inch past the resistance point, until the center of the nut is located approximately 1/2 inch from the edge of the chassis.

As shown in Figure 6, 1.8-A (ampere) power supplies are identified by part number 699-0189. 1.2A power supplies are identified by part number 620-6103. Both supplies are marked "120 V AC 150 W," but the 1.8-A model is actually a manual switching dual voltage (110/220-V AC) model, and it's also 50% stronger!

Here are the figures: Power = Voltage x Current. Substituting Lisa 2 / 10 to Mac XL power supply values: 120 V AC x 1.8 A = 216 W (44% over specification). Substituting Lisa 2 / 5 power supply values: 120 V AC x 1.2 A = 144 W (4% under specification).

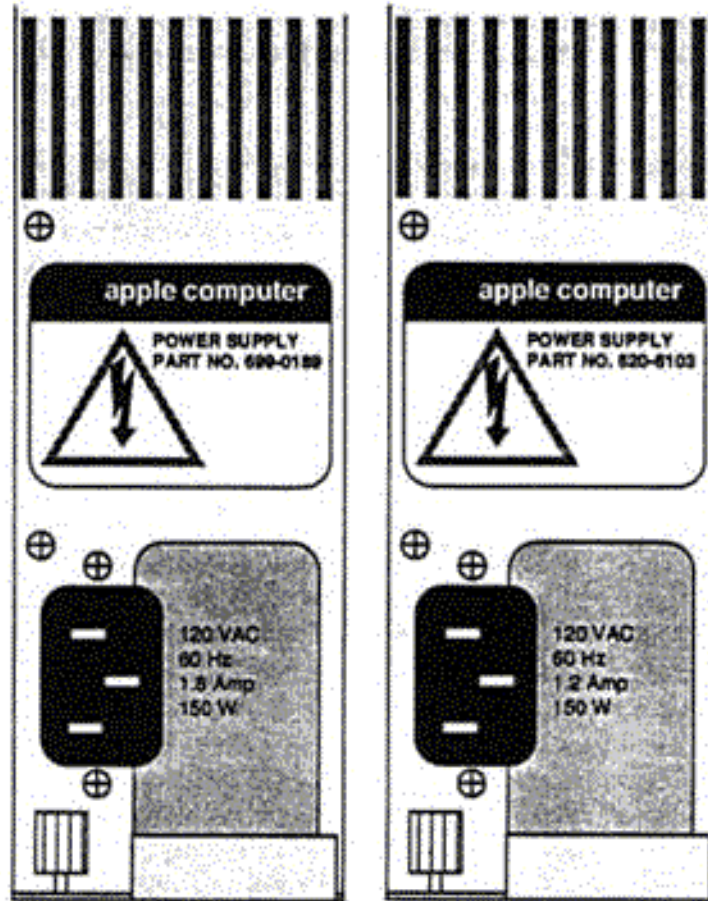

Figure 6

Lisa/Mac XL power supplies external views. 1.8-A Lisa 2/10 to Mac XL power supply (left), and 1.2-A Lisa 2/5 power supply (right) are both marked "150 W," but the 1.2A model is actually a dual voltage model, and it's 50% stronger!

So how can both models be marked 150 W? The acceptable input voltage specified in the Lisa 2 literature is 90 V AC to 130 V AC. Substituting 90 V AC (the low limit) into the Lisa 2/10 to Mac XL supply's formula ($90 \text{ V AC} \times 1.8 \text{ A}$) lowers its relatively high rating to 162 W. Substituting 130 V AC (the high limit) into the Lisa supply's formula ($130 \text{ V AC} \times 1.2 \text{ A}$) raises its relatively low rating to 156 W. Since both figures exceed 150 W, that presumably explains the identical ratings. Nevertheless, the Lisa 2/10 to Mac XL supply is notably superior.

When the original 1.2-A Lisa 2/5 supply is used with an internal hard drive and a Macintosh XL Screen Kit (described at the end of this chapter), audible transformer ringing results, horizontal retrace lines become noticeable, and a slight screen flicker is introduced. Installing the 1.8-A Lisa 2/10 to Mac XL supply eliminates all of that.

The 1.8-A Lisa 2/10 to MacXL supply is also a dual voltage model. 110 to 220-V AC conversion is made by moving two jumpers at the bottom of the board, as shown in Figure 7.



These differences make a very important point. If you only remember one thing from this: Always confirm specifications by making your own calculations.

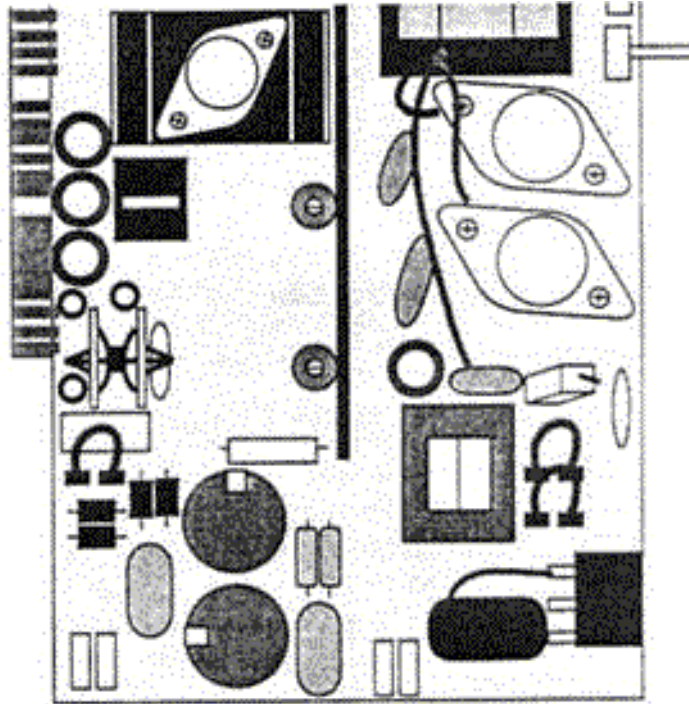

Figure 7

Lisa 2/10 to Mac XL power supply-1 10- to 220-V AC conversion (1.8 A model only) is made by moving two jumpers at the bottom of the circuit board.

The card cage is a removable rack for the Lisa's circuit cards. It's also held by tight-fitting tongue and socket connectors. To remove it, disconnect all peripheral cables from the back of the computer, brace your thumbs underneath and pull straight back as shown in Figure 8.

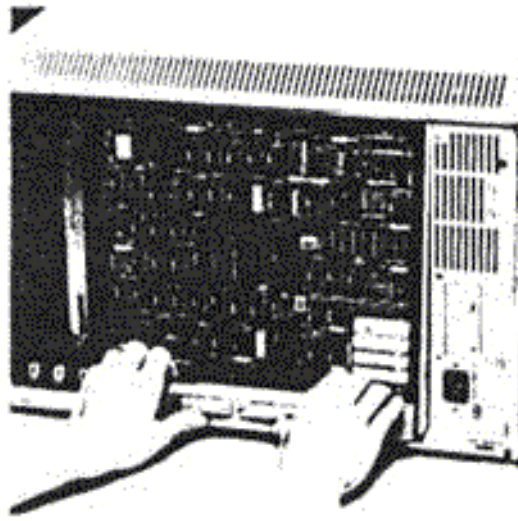

Figure 8

To remove the card cage, brace your thumbs and pull straight back.

The mother board is fixed to the bottom of the cage and there may be three or four removable cards (depending on how much memory you have) arranged vertically, from back to front, as shown in Table 2.

Table 2 Replaceable circuit cards

Card	Lisa Part#	XL Part#	Color Code
System I/O	620-0117	620-142	Red & brown
CPU	620-0119	620-0119	Blue & brown
Memory 1	620-0112	620-0112	Yellow & brown
Memory 2	620-0112	620-0112	Yellow & brown

Note that part numbers beginning with 620 refer to a complete circuit card (defined as a plug-in circuit board with all the parts on it), not an empty board, which is always referred to by another number beginning with 820. All four cards fit into tongue and socket connectors on the mother board. To remove a card, loosen the color coded bails and pull straight up. The four cards slip in and out easily, and the design makes it impossible to reinstall them backwards; although, it's very easy to get confused. Note that the CPU card faces backward, while the System I/O card faces forward. If the CPU card offers the least bit of resistance when you try to put it in, it means you're holding it wrong. Don't force anything! Check the color codes as illustrated in Figure 9. The Memory cards and the CPU card on Lisas and Mac XL's are interchangeable. The System I/O cards are not (The XL I/O card will work in a Lisa but a Lisa I/O card will not work in an XL) Physically, they fit, but electrically there are problems with disk-drive control. If you just bought a used Lisa, or if you're restoring a Lisa and can't seem to get it going, it's important to check for the correct System I/O card. The differences are shown in Figures 10 and 11.

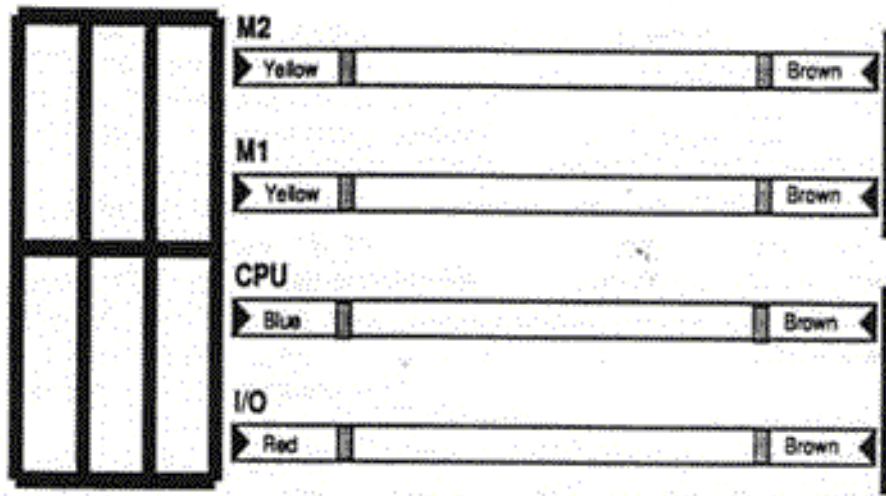

Figure 9

Top view of the Lisa/XL card cage. Bail colors indicate proper orientation.

ROM differences on the I/O may also be present if you have upgraded your computer with a 800K floppy drive. If a screen modification kit is present in your computer the CPU card will have a different chip. If you are going to replace the CPU card and you are using the Lisa Office System, you will need to switch Video State ROM chips. If you fail to do this your Office System will not work because it is specially coded to that chip.

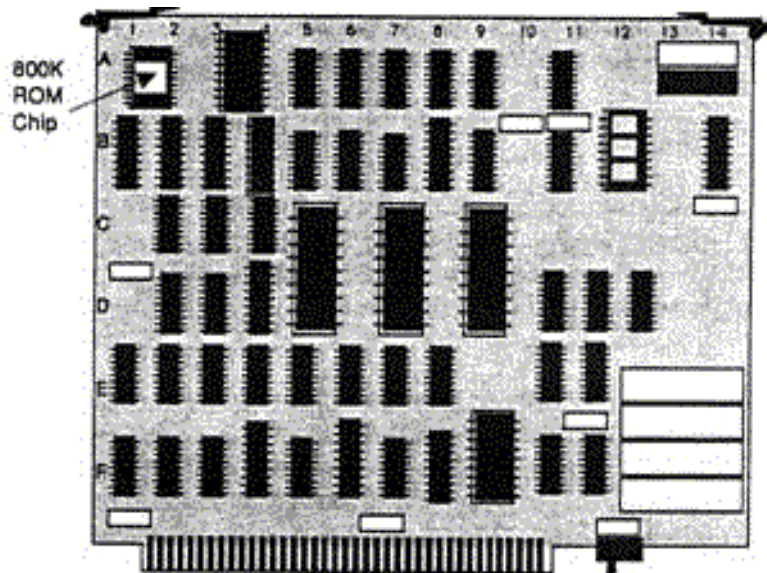

Figure 10

The Lisa I/O card. Note the battery pack (lower right) and the AMD 9512 coprocessor socket (upper right).

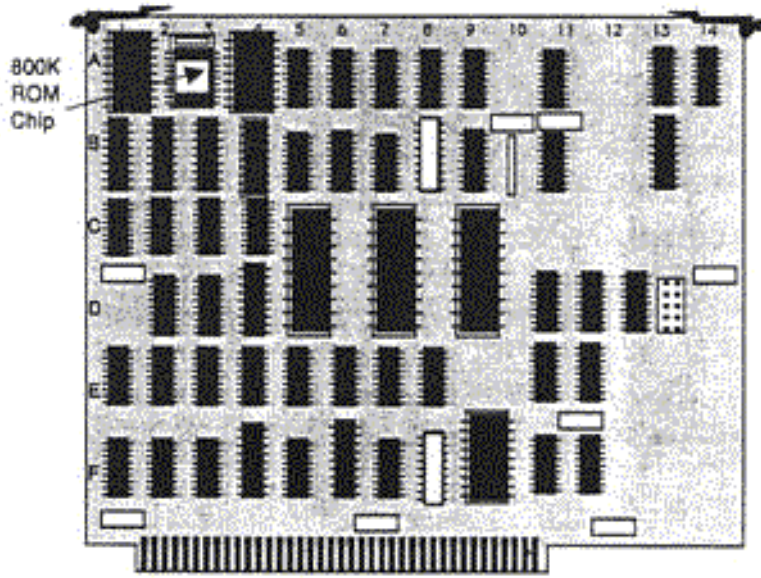

Figure 11

The Mac XL 1/0 card. There's no battery pack (lower right) and no socket for the AMD 9512 coprocessor (upper right)!

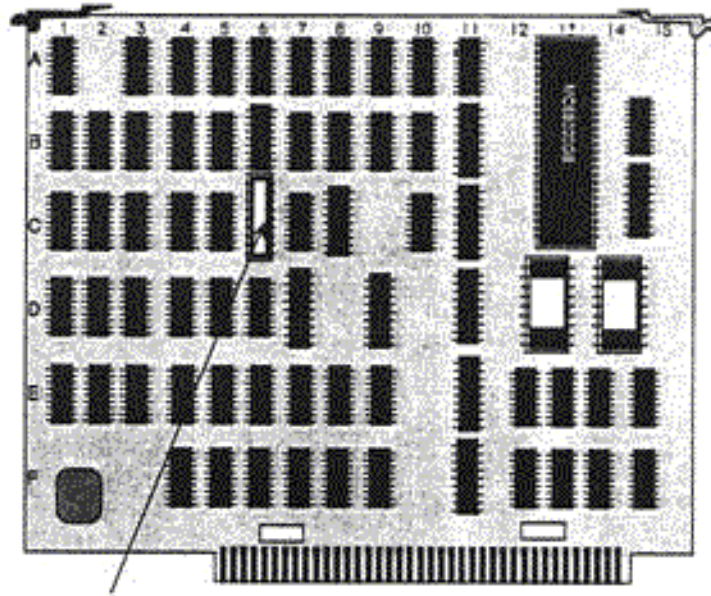

Figure 12

Be sure to switch the Video State ROM on the CPU when you replace CPU cards if you are using the Lisa Office System.

While the card cage is out, peek inside the chamber and find the two hidden screw holes on the underside of the top cover as shown in Figure 13. When you need to remove the top cover, use a #2 Phillips-head screwdriver to loosen the screws until they dangle, then slide



the cover forward and lift straight up. Both screws are permanently attached to the chassis. You don't have to worry about them falling out.

Once you've determined that the hardware configuration is correct, the Lisa's automatic startup tests will tell you if everything is working OK. It's important to verify the hardware setup before proceeding, because if the wrong boards are in your machine, the test results may be invalid.



Automatic Startup Tests

Every time you turn on the Lisa, it runs an exhaustive series of tests in the following sequence:

ROM Checksum

If the ROM Checksum fails, the computer hangs. When the CRT warms up, the screen may appear blank or it may display random patterns. These symptoms indicate a problem with the ROM chips, which are on the CPU board at locations D13 and D14. There are several things to check before ordering new ROMs:

1. Make sure the chips are oriented correctly. The notches should be pointing up. There were several ROM versions. Someone could have tried to install new ROMs, put them in backwards, and given up at that point.
2. Make sure they're in the right sockets. If you have a stock Lisa with "H" ROMs, part number 341-0176-H should be in the socket at D14, part number 341-0175-H should be in the socket at D13. If you have a modified Lisa with "3A" ROMs, part number 341-0346 should be in the socket at D14, part number 341-0347 should be in the socket at D13. Any other part numbers indicate old (buggy) ROMs. Replace these on principle. It's usually not necessary to buy ROMs separately. The latest 3A ROMs are included with the XL Screen Kit, a video upgrade described later in this chapter.
3. Make sure there are no bent pins on the ROMs.
4. Make sure both chips are fully seated.

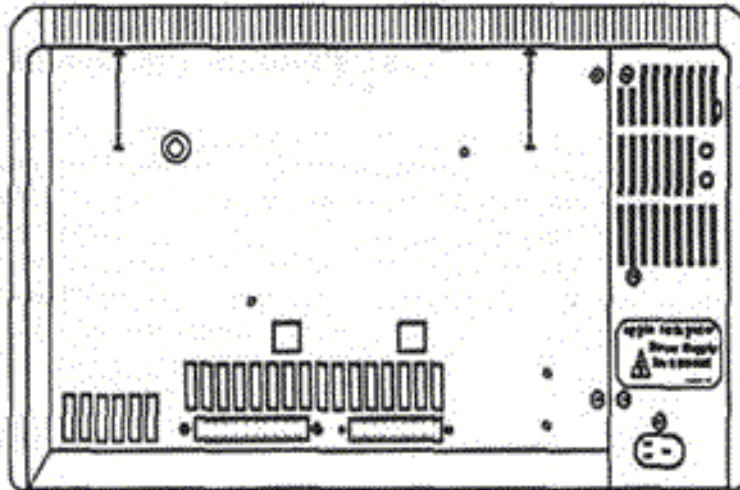

Figure 13

The top cover is removed by loosening two hidden screws attached to the roof of the chamber. Both screws are permanently attached to the chassis. They won't fall out!

If you find any one of the above problems, pull the chips, replace them, reorient them, and/or straighten the pins as necessary.



MMU Register Test

An initial failure of the MMU Register Test causes an endless loop. When the CRT warms up, it'll be blank. Other failures display error code 40 and show a cross over the CPU board icon. (Refer to Table 3.) Both symptoms indicate a problem in the memory

management unit, which is made up of various static RAM chips. Each of these components is soldered in place which makes substitution very difficult.

When the MMU Register Test fails, make sure the CPU board is seated firmly, check for oxidation on the gold fingers, check for any obvious bad solder joints, and if that doesn't turn up anything, replace the board.

Memory Sizing

This test counts the installed memory. Errors are pretty much ignored, but if the memory can't be accessed at all, say both cards are missing, the speaker beeps, and the computer hangs with a series of alternating black and white stripes. The pattern is shown in Figure 14.

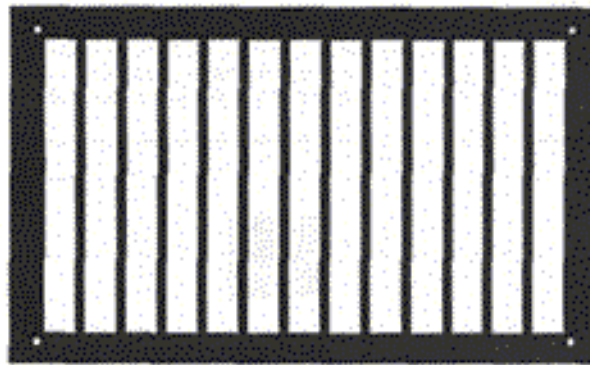

Figure 14

This pattern indicates total RAM failure. On the Lisa, Mac XL, Mac Plus, and Mac SE it generally means the cards and/or SIMMs are missing. On the 128K to 512KE with certain memory upgrades, it generally indicates a problem with the 68000 chip.

The fix is to install or reset the cards. If necessary, clean the contacts with a pencil eraser. They're gold plated so they should be nice and shiny. Remove the eraser dust with a dry cloth. Try not to touch the contacts with your fingers. It's best to keep them oil-free.

Preliminary Memory Test

The startup ROM uses the first 2K of memory. If there's a problem with the first 2K, the speaker beeps twice and the computer hangs with a random display on the screen. This indicates a problem with the memory card in slot 1, the slot closest to the middle of the card cage. Verify by removing the card and trying again. So long as there's a second card in slot 2, the slot closest to the edge of the card cage, the computer will still boot, and, assuming that card's OK, testing will continue.



VIA Test

VIA is an acronym for Versatile Interface Adapter. The Lisa uses two 40-pin 6522A chips, the same chip used on other Macs. The chip at D7 (marked "keyboard") provides keyboard logic, a real time clock, and mouse control; the chip at DS (marked "parallel port") controls the parallel port. Both chips are labeled and socketed. If this test fails with a cross over the 1/0 board icon and error code 50 (keyboard VIA problem) or error code 51 (parallel port VIA problem), here's what to do:

1. Make sure the suspect VIA chip is installed. On a used or surplus Lisa, someone might have pulled it!
2. Make sure it's oriented correctly. The notch should be pointing up.
3. Make sure there are no bent pins on the chip.
4. Make sure the chip is fully seated.
5. If that doesn't turn up anything, it's worth trying a new VIA chip before scrapping the board.

The VIA test may also fail with a cross over the 1/0 board icon an error code 58, indicating an 1/0 access problem or with a cross over the 1/0 board icon and error code 41, indicating an 1/0 decode problem. In either case:

1. Make sure the CPU board is seated firmly.
2. Check for any obvious bad solder joints.
3. Make sure the 68000 is oriented correctly. The notch should be pointing up.
4. Make sure there are no bent pins on the 68000.
5. Make sure it's fully seated.
6. Make sure it's an 8-MHz 68000. Someone may have tried substituting a faster CPU. The OEM part is marked MC68000G8.

If that doesn't turn up anything, its worth trying a new 68000 before scrapping the board.

I/O Board Tests

I/O is an acronym for Input/Output. If both input devices (the keyboard and mouse) are connected, the speaker emits a single click. Otherwise, you're alerted (by an icon and a series of tones) that they're not connected. The click or the input device alert completes the kernel tests. Up to this point, only two or three seconds will have passed since the power button was



pushed. Next, the Lisa runs module tests. When the screen warms up, you'll see a Startup Module Test Display as shown in Figure 15.

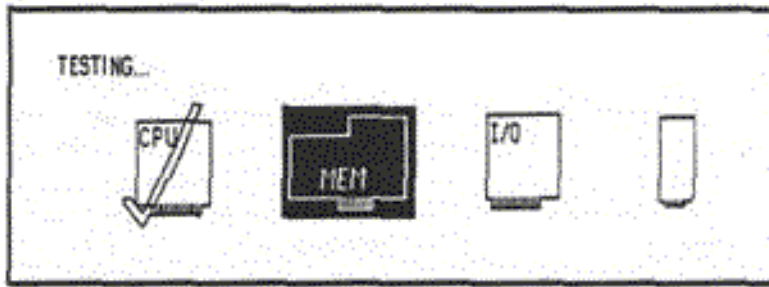

Figure 15
The Startup Module Test Display.

As each module passes, it's marked with a check mark, Errors result in a cross over the module with an error code underneath. A complete list of error codes is given in Table 3.



Table 3 Startup Error Codes

Code	Icon	Symptom	Solution
N/A	Drive opening	No diskette	Insert disk
23	Diskette	Unreadable diskette	Reformat disk
38	Diskette	No startup file on diskette	Install system
39	Diskette	Drive ROM can't keep up	Wrong drive ROM?
40	CPU card	Memory management problem *	
41	CPU card	Selection logic problem	*CPU card missing?
42	CPU card	Video circuit problem	*
43	CPU card	Parity circuit problem	*
44	Lisa	Unexpected NMI interrupt	
45	Lisa	Bus error	
46	Lisa	Address error	
47	Lisa	Unexpected exception	
48	Lisa	Illegal instruction	
49	Lisa	Line 1010 or 1111 trap	
50	I/O board	Keyboard VIA error	6522A chip? *
51	I/O board	Parallel VIA error	6522A chip? *
52	I/O board	I/O COPS error	COPS chip? *
53	I/O board	Keyboard COPS error	COPS chip? *
54	I/O board	Clock error	*
55	I/O board	Serial port A problem	Z 8530 chip? *
56	I/O board	Serial port B problem	Z 8530 chip? *
57	I/O board	Disk controller problem	Lite Adapter? *
58	I/O board	I/O board access error	*
59	I/O board	I/O COPS error	*
60	I/O board	I/O or keyboard error	*
70	Memory board	Read/write error	
71	Memory board	Parity error	
75	Internal HD	System files are damaged	Reinstall System
75	External HD	System files are damaged	Reinstall System
75	Floppy disk	System files are damaged	Reinstall System
75	Expansion card	System files are damaged	Reinstall System
80	Internal HD	Drive cable is disconnected	Check cable
80	External HD	Drive cable is disconnected	Check cable
81	Internal HD	No response from drive	Adjust solenoid?
81	External HD	No response from drive	
82	Internal HD	Drive doesn't answer	
82	External HD	Drive doesn't answer	
83	Internal HD	Other drive problem	
83	External HD	Other drive problem	
84	Internal HD	Boot blocks are damaged	Low level format?
84	External HD	Boot blocks are damaged	Low level format?
85	Internal HD	Drive can't keep up	
85	External HD	Drive can't keep up	
90	Expansion card	No card in that slot	Remove Card
91	Expansion card	Can't start from that card	Remove Card
92	Expansion card	Problem with the card ROM	Remove Card
93	Expansion card	Other card problem	Remove Card

* Clean gold fingers and reseat the board.

ROM Identification



Another function of the startup module test is to identify which versions of the ROMs are installed. The version numbers appear in the upper right corner of the screen. The letters and numbers to the left of the divisor refer to the boot ROM. The letters and numbers to the right of the divisor refer to the drive ROM. A list of what you should see is given in Table 4.

Table 4 Acceptable Lisa/XL ROM Versions

Version	Computer	Meaning
H/A8	Lisa 2	Stock screen—90 x 60 dpi
3A/A8	Lisa 2	Modified screen—72 x 72 dpi
H/88	Lisa XL	Stock screen—90 x 60 dpi
3A/88	Lisa XL	Modified screen—72 x 72 dpi

H/A8 indicates a stock Lisa 2. 3A/A8 notes the presence of an XL screen kit, indicating a modified Lisa 2. H/88 indicates a stock Mac XL. 3A/88 indicates the presence of an XL screen kit, indicating a modified Lisa 2-110 or a Modified Mac XL. Watching the ROM codes is the easiest way to determine whether an XL screen kit is installed. For reference, write down whatever codes are displayed.

Booting the Operating System

The next step is to boot an operating system (OS). One of the biggest problems veteran Mac owners have with Lisas and Mac XL's is understanding (conceptually) why this step is necessary. On the Macintosh, half of the OS is loaded transparently from ROM, and the other half loads from a startup disk, defined as any disk containing System and Finder files. It's simple.

The Lisa/Mac XL boot procedure is more complicated, because Lisas were designed to run multiple operating systems (Lisa Office System, Lisa Pascal Workshop, MacWorks XL, MacWorks Plus, etc.). That capability precludes putting half of any particular operating system in ROM. Instead, 100% of whatever OS you choose to run has to be loaded from disk. In practice, the allowable operating systems are permanently installed on one of seven partitioned hard disks, where they load automatically, according to modifiable startup preferences, upon completion of the module tests. If your Lisa or Macintosh XL is equipped with a SCSI hard disk, MacWorks Plus must be loaded from a floppy disk to recognize your SCSI drive.

If you own a SCSI drive, there's no hard disk connected, or if it's powered down, two buttons appear on the Lisa/XL screen instead. To load MacWorks from a floppy (as might be necessary on the repair bench), click the "Startup From..." button, insert a MacWorks 3.0, MacWorks XL, or MacWorks Plus disk, then click the disk drive icon. If you boot MacWorks 3.0 or MacWorks XL, 64K ROM emulation will load into RAM. If you boot MacWorks Plus, 128K ROM emulation will load into RAM. Upon completion, the MacWorks disk kicks out, and the familiar blinking 3.5-inch floppy disk icon appears. If you have a SCSI drive, the system

*Lisa*

on your drive will load. From that point forward, the machine will operate just like any other Macintosh.

One Caveat: Following through with inappropriate versions of the System and Finder will crash the machine. Acceptable System/Finder combinations for use with MacWorks 3.0 and MacWorks XL include 2.0/4.1 and 3.2/5.3. These are the exact same limitations that 512K Macs have. Additionally, you must load the System and Finder from an MFS (Macintosh File System) disk. HFS (Hierarchical File System) disks are not recognizable on any Mac under the 64K ROMs.

MacWorks Plus version 1.07 or greater requires at least System/Finder 6.02/6.1. In this case, previous versions of the System and Finder result in a crash. The important thing to remember is that system crashes of this nature have nothing to do with the hardware. Once you get to the blinking floppy disk icon, you can assume that the machine is OK. If your computer restarts after this point, the problem is most likely with the system folder. It may also fail if you only have 512K RAM installed.



Lisa/Mac XL Test Diskette

The Lisa/Mac XL test diskette tests the electronic components in the Lisa/Mac XL system. This test will determine if any of the electronic boards or devices are defective and need to be replaced.

To start the test, insert the test diskette and turn on the computer. Shortly after the computer is turned on you will hear a soft click. When you hear the click, press the space bar a few times. The next screen that will appear will be the "startup from" screen. Startup from the floppy drive by pressing the Ilk 2 keys.

The next screen will show the version of the Lisa/Mac XL test you are using as well as the release date of that version. If you have a screen modification kit you must use the Mac XL/Lisa screen modification kit diagnostics version 1.0. If you do not have a screen modification kit you must use Lisa/Mac XL Test Release 3.0. This screen will then disappear and the following screen will appear.

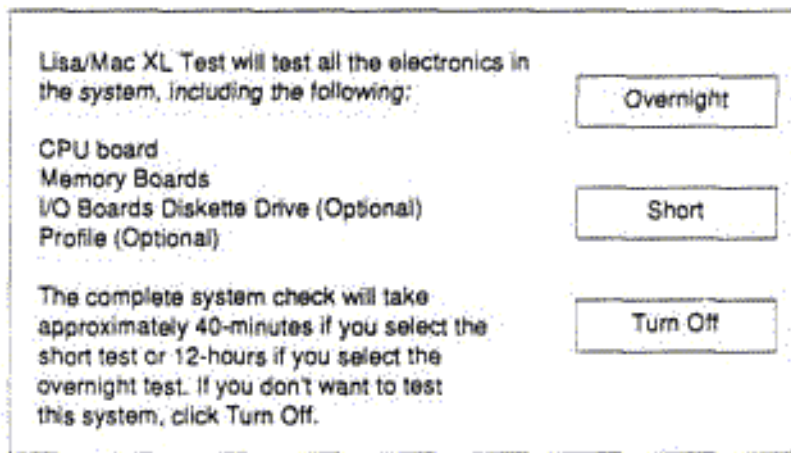

Selecting either the overnight or short test will then give you a new screen asking you if you want to test the diskette drive, continue to the next item to test or turn off. After the test of the drive or if you select continue the next screen will give you the same options except this will be to test the hard drive.

When the test of the hard drive is complete or continue is selected, the computer will start the test of the CPU Board. You can terminate this test by holding down the apple key and typing a period. The computer will then proceed to check the memory boards and the I/O board. The screen will flash or flicker during these three tests. Do not be alarmed. This is normal to check the different components and their functions.

When all components have been checked and all is working properly your screen will appear as follows.



Lisa

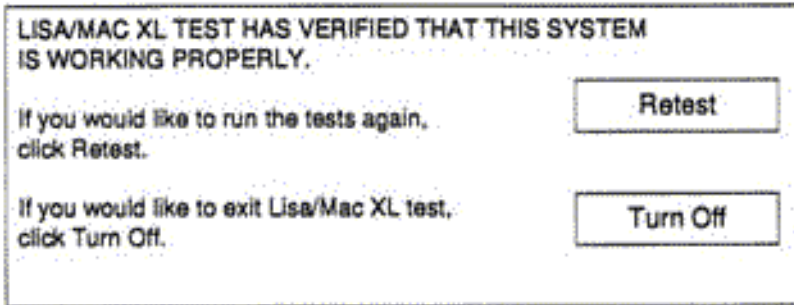

Select either Retest or Turn Off. If you select Turn Off, the screen will dim and after about fifteen seconds and the computer will turn itself off. You can then turn the computer on and begin normal operation. If the test did detect an error with one or more of the boards you would see a message indicating which board or device is causing the error and needs to be replaced.



Built-in Service Mode

In addition to the automatic startup tests, the Lisa has built-in service mode. Some tests are easy to figure out. Adjust Video, for example, puts up a 1/2 inch reverse video crosshatch. Here's how to enter the built-in service mode:

1. If the computer is on, turn it off. Wait a few seconds, then without inserting a startup floppy disk, turn the computer on again.
2. At the end of the kernel test (when you hear the first click), hit any key except Caps Lock. Hitting a key interrupts the normal startup procedure and turns on the Startup From mode.
3. At the end of the module test (when you hear the second click), hold down the Apple key and press the 2 key.
4. Since there's no floppy disk in the disk drive, the Lisa beeps three times and presents you with an error box. Ignore it!
5. Hold down the Apple key and press the s key. S presumably stands for service. Case is irrelevant. Pressing S, or s, will engage the service mode as shown in Figure 16.

Note that the numerical shortcut keys for the menu items don't require pressing the Apple key. If you'd rather not use the mouse, just press the numerical keys (all by themselves) to engage the tests. Press and, if necessary, hold down the Return key to return to the main menu. Press 7, not Apple 0, to Quit. Press the Reset button at the back of the computer to exit an endless loop.

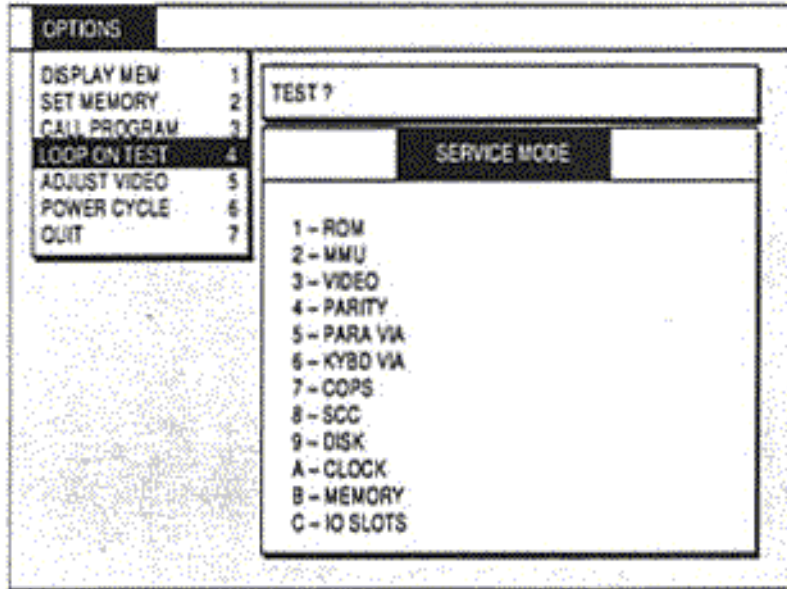

Figure 16

The Lisa's built-in service mode. Use with caution!

Warning! The Power Cycle & Loop On Test presume a stock hardware configuration. They should not be used with a modified Lisa 2 or a Macintosh XL. Running the Power Cycle test with an 800K disk drive upgrade will cause the disk drive test to fail. Running the Power Cycle test on a Lisa 2/5 with an internal hard drive upgrade could wipe out the boot blocks on the hard disk. On startup, you'll get a cross over the hard disk icon with error code 84. You'll still be able to boot from a floppy, and the hard disk will mount, but in order to boot from the hard drive again, you may have to remove it, and send it out for a low level format. Use with extreme caution!

Summary of the Diagnostics Routines

The Lisa's built-in diagnostic routines display various icons accompanied by error codes pointing to particular electronic components. In practice, electronic failures are seldom seen. The most common problems result from mechanical failures, especially with the disk drives. The next section tells how to deal with them.



Mechanical Problems with the 3.5 Inch Disk Drive

Just like its Macintosh counterpart, the Lisa's 400K 3.5-inch disk drive is subject to the following failures:

1. Eject mechanism makes eject noises but disks don't come out.
2. Eject mechanism fails to operate (doesn't make any eject noises at all) when rebooting after a System crash.
3. Grinding noises get louder and louder. Disks become unreadable.

The first failure indicates a lubrication problem. The second failure indicates the presence of an OEM 400K Mac drive. The third failure indicates a dirty stepper cam, a dirty head, and/or a clogged pressure pad. If disks don't read properly, try cleaning the heads.

The Sun 800K floppy is a little different. If your drive continually ejects, remove pins 9 and 20 from the drive cable. If your drive seems to be moving abnormally slow, check for an 800K ROM on the I/O board.

Drive Makes Eject Noises but Disks Fail to Eject

When the drive makes eject noises but the disks don't come out it usually means that the grease on the eject mechanism has solidified. To fix it, all you have to do is disassemble the eject mechanism and change the grease. Here's the complete procedure:

1. Disconnect the computer's power cord from the wall outlet.
2. Remove the disk drive cage as shown in Figures 1 to 3.
3. Disconnect all data and power cables from the installed drives.
4. Remove the internal disk drive by tilting the drive cage forward and loosening four Phillips-head screws at the bottom. Use a #1 Phillips-head screwdriver. Support the drive with one hand as shown in Figure 17.

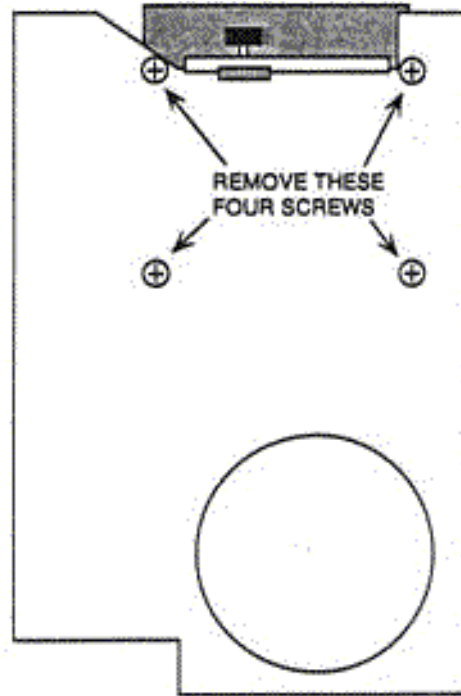

Figure 17
Lisa disk drive removal.

5. Use a small 1/8-inch slotted screwdriver to remove the C-ring shown in Figure 18.
6. Rotate the drive such that the disk opening is facing down and the eject motor is facing up. Use a small 1/8-inch slotted screwdriver to remove a single black flat-head screw behind the eject motor. Remove the top cover.
7. Rotate the drive such that the circuit board is facing up. As shown in Figure 19, use a small 1/8-inch slotted screwdriver to remove four gold-colored flat-head screws mounted beneath the circuit board.

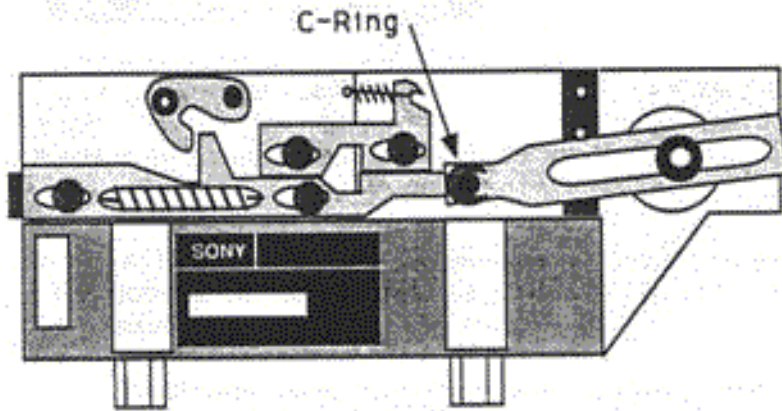

Figure 18
C-ring removal.

8. As shown in Figure 13-20, disengage the disk carrier mechanism from the chassis.
9. With clean paper towels, wipe up as much of the old sticky grease as you can. The more you wipe up now, the less you'll have to dissolve later.
10. Set up a disposable aluminum tray as shown in Figure 21. Hold the eject mechanism over the tray and spray the remaining grease away with WD-40.
11. Work the levers back and forth as shown in Figure 22. Arrows are shown on the release points. Work these points back and forth and respray as necessary until all of the old grease is gone.

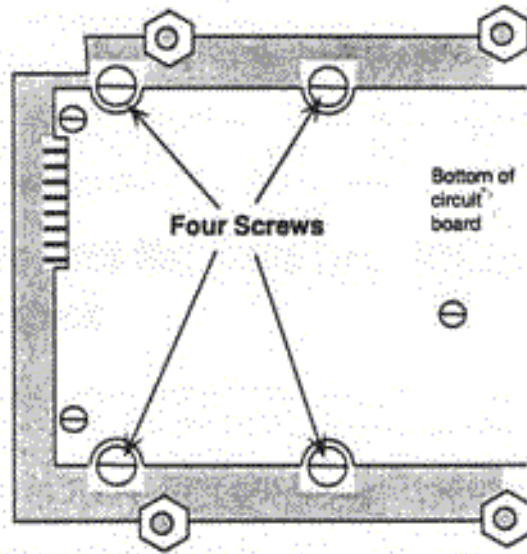

Figure 19
Carrier mechanism screw locations.

Note that the three additional gold-colored screws on top of the circuit board do not have to be removed.

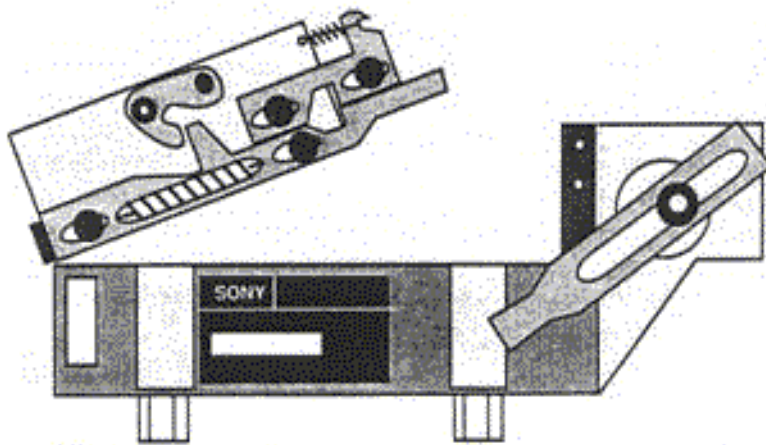

Figure 20
Carrier mechanism removal.

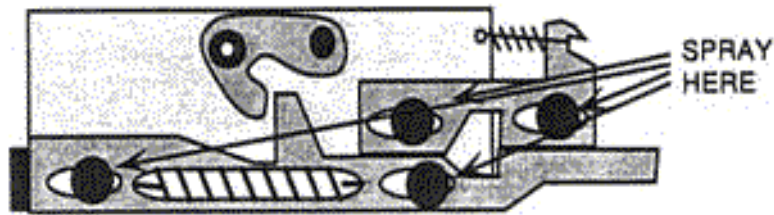

Figure 21

Spray away the old grease with WD-40.

12. WD-40 both removes the old grease and relubricates the drive. No additional lubrication is necessary. Reverse steps 8 through 1 to reassemble the repaired disk drive.

Relubricated carrier mechanisms work as good as new. Repairs last indefinitely because, unlike grease, WD-40 can't solidify.

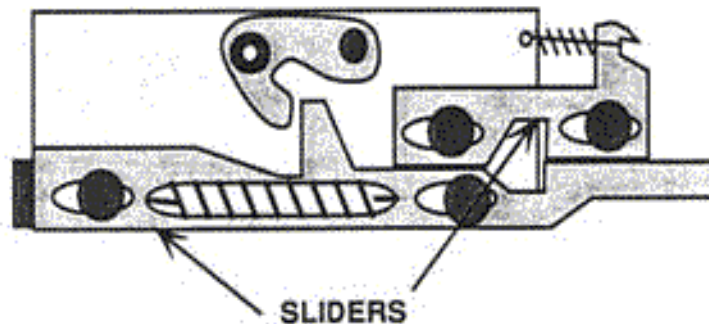

Figure 22

Work the sliders back and forth until all of the old grease is gone.

The same procedure works for 400K Macintosh disk drives as well. The lubrication principles also apply to 800K Mac drives. Unless you operate in an hermetically sealed environment, all autoeject drives eventually develop problems with the carrier mechanism. Tiny eject motors don't have nearly the same strength as a human finger on a push button, Periodic relubrication is (or at least it should be) part of routine maintenance.

Drive Does Not Make Eject Noises and Disks Get Stuck

Occasional eject failures which are not accompanied by eject noises indicate that the OEM Lisa drive has been replaced with an OEM Mac drive. Despite the mechanical similarity between 400K drives (right down to the part numbers!), the OEM Lisa model has a different eject mechanism. It's always triggered on shutdown, whether there's a disk in the drive or not. The OEM Mac model is not triggered, unless there is a disk in the drive. Since the Lisa can't do a disk check after a System crash, Mac drives fail to eject them when you restart the



computer. Inserted disks remain in the drive, and the Lisa's boot ROM doesn't know what to make of them. There are three possible fixes.

One is to drill a 1/16 inch hole to the right of the drive opening (just like small Macs) and use a straightened heavy-duty paper clip to eject the disks. The second is to repair and reinstall the original Lisa drive. The third is to install MacWorks Plus version 1.0. 18 or later. Because MacWorks Plus includes 800K drive support, and since the only difference between a 800K Lisa drive and an BOOK Mac drive is the mounting hardware, this problem was (and had to be) taken care of, or the 800K Lisa disk drive would malfunction exactly the same way. MacWorks Plus cures many long-standing Lisa problems. We'll be taking a very close look at it towards the end of this publication.

Grinding Noises

Grinding from the disk drive indicates a dirty stepper cam, a dirty head, and / or a clogged pressure pad. Clean the cam shaft with cotton swabs and WD-40, but don't loosen the cam retaining screw. Dirty heads should be cleaned the same as tape recorder heads. For easier access, pull back the pressure pad assembly as shown in Figure 23. Use a cotton swab moistened with tape head cleaner.

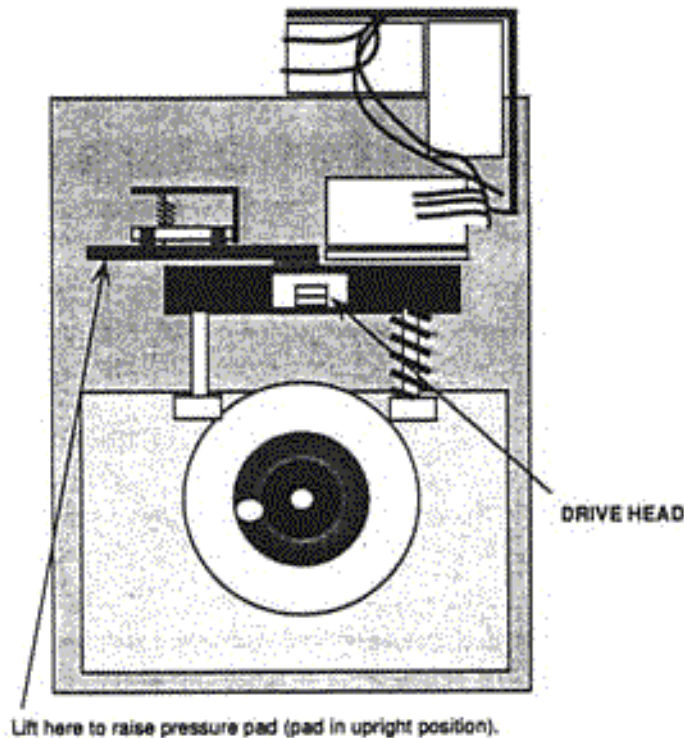

Figure 23

For easy access to the 400K drive head, pull back the pressure pad assembly.

The pressure pad is made of a cotton-like material. Brush it clean with a small lint brush. If none is available, flick the surface with your fingernail. Depending on the age and condition



Lisa

of the drive, be prepared for a surprising amount of disk dust] Cleaning fluids should be avoided; they tend to be absorbed.



Hard Drive Repairs

The Lisa's OEM parallel hard drives (external Profile drives and internal Widget drives) are subject to three common problems:

1. Startup error code 81 -pertains to 10MB Widget drive.
2. Startup error code 84-pertains to all Lisa hard drives.
3. Sad Mac error code OF0064-pertains to all Lisa hard drives formatted under MacWorks 3.0 or MacWorks XL. This is a system folder error message.

Startup Error 81

Startup error code 81 pertains primarily to the Lisa 2/10 and the Macintosh XL. Both models have a 10MB internal hard drive equipped with an electric brake. On startup, immediately after completion of the module tests, the electric brake makes a distinct clunk. If there's no clunk, it means the brake froze (didn't release). If the brake freezes, the hard disk can't spin; the result is a cross over the internal drive icon with error code 81 as shown in Figure 24.



Figure 24

Error code 81 indicates a problem with the brake solenoid.

Without further information, many people assume that they need a whole new hard drive. Rather than spend the money, they shelve the computer. Well, it's time to dust it off! Error code 81 simply means the brake is out of adjustment. You can fix it, easily, in under an hour, with a #1 Phillips- head screwdriver and a .012-inch feeler gauge. Here's the complete procedure:

1. Disconnect the computer's power cord from the wall outlet.
2. Remove the disk-drive cage as shown in Figures 1 to 3.
3. Disconnect all data and power cables from the installed drives.
4. Turn the cage upside down. This puts the relatively light disk drive on top and the relatively heavy hard drive on the bottom.

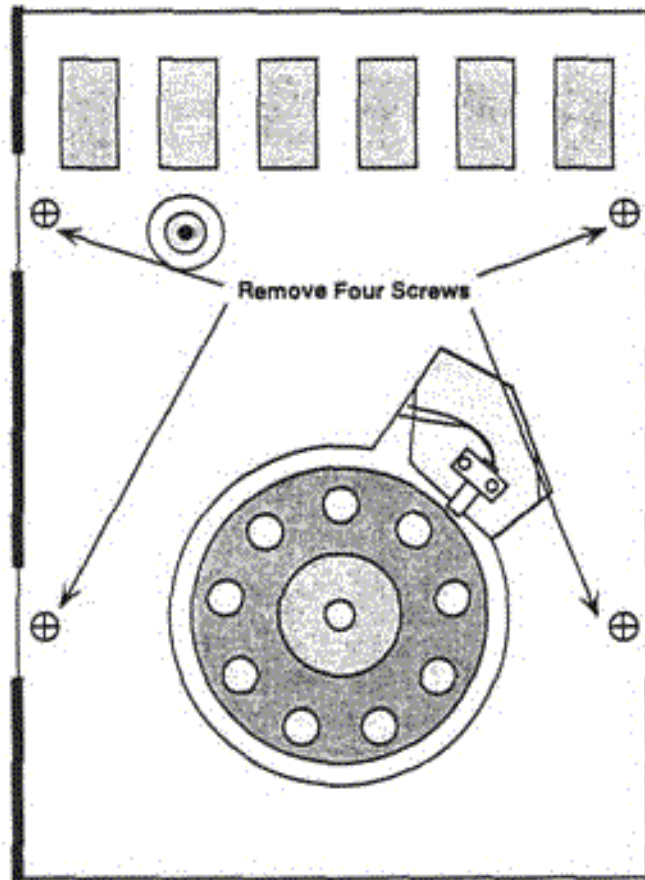

Figure 25

Four screws hold the sheet metal support bracket.

5. Use a #1 Phillips-head screwdriver to remove six screws (three on each side of the cage) which hold the hard drive in place.

6. Lift the drive cage straight up. This leaves the hard drive upside down on the table.

7. Use a #2 Phillips-head screwdriver to remove four screws from the sheet metal support bracket as shown in Figure 25. Lift the bracket away and put it aside.

8. Locate the solenoid marked "Inertia Dynamics, Collinsville, CT USA." Insert a 0.012-inch feeler gauge as shown in Figure 26.

Tighten the screw, reverse steps 7 through 1, and everything should be OK! If not, repeat steps 1 through 9, allowing a little more or a little less clearance, until you get the brake working.

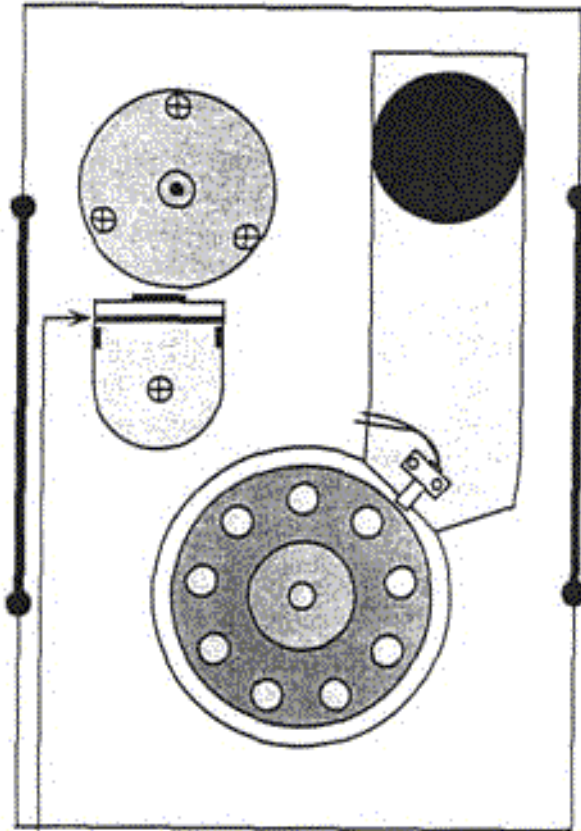

Figure 26

Adjust the brake with a 0.012-inch feeler gauge.

9. At the time of failure, clearance might be as much as 0.075 inch. Loosen the solenoid holding screw and adjust for 0.012-inch clearance.

Startup Error 84

Startup error code 84 pertains to Profile and Widget drives. It means the boot blocks are damaged. There are three possible fixes.

Fix one involves double-reformatting the drive---first under Lisa OS, then under MacWorks XL. Double-reformatting the drive is time-consuming and it only applies to unmodified computers. You can't use this method with a Macintosh XL Screen Modification Kit unless you pull the 3A ROMs and reinstall the old ROMs. Also, double-reformatting doesn't always work.

Fix two involves reformatting the drive with MacWorks Plus version 1.0. 18 or later. Holding down the Apple and the left Option keys while double clicking the MW Install icon opens the program in the expert mode. Expert mode recognizes most unmountable drives and gives the option to you to reinitialize them. Afterwards, the drive may or not be bootable.



Fix three involves sending your drive to Sun Remarketing. Using a special machine, Sun technicians can do a low level format, which rewrites the boot blocks, then a high level format, which installs the latest version of whatever operating system you've been using (Lisa OS, MacWorks XL, or MacWorks Plus). This method always works and it's a lot less painful than having to buy a whole new drive. SCSI drives can be repaired by using utilities such as Norton Utilities.

Sad Mac error code 0F0084

Sad Mac error code 0F0064 pertains to any Lisa hard drive formatted under MacWorks 3.0 or MacWorks XL. At the time the original MacWorks was written, other Macs weren't equipped with hard drives. The old System software, written to 400K floppy disk specifications, has trouble dealing with big disk directories. If over 100 files accumulate, everything slows down and eventually fails. Error code 0F0064 generally indicates an irreparable problem with the System & Finder. There are three possible fixes. The first fix involves rebooting from the hard drive while holding down the Option key. (If you are looking at the sad Mac screen hold down the left option key and press and release the power switch button.) If MacWorks itself is OK, you'll get a floppy disk icon with a blinking question mark. At that point, insert the MacWorks System disk. It'll load, you'll get the standard "Welcome to Macintosh" signon message, and, shortly thereafter, both disk icons (the floppy disk icon and the hard disk icon) should appear. Now all you have to do is replace the System files. To do that, open the System folder on the MacWorks System disk, select the System & Finder and drag them to the hard disk. A dialog box asking whether to "Replace items with the same names with the selected items?" will appear. Click OK and that's all there is to it.

The second fix applies when the hard drive icon doesn't appear. In that event, you need a special disk called Hard Disk Mount. Hard Disk Mount may be obtained from Sun Remarketing for a cost of \$15. Here's the complete repair procedure:

1. If the computer is on, reach around the back with your right hand and press the reset button. If the computer is off, turn it on.
2. Immediately after hearing the first click, tap any key but Caps Lock.
3. When the STARTUP FROM menu appears, insert the HD Mount disk and click the disk drive icon or hold down the Apple key and press the 2 key (the one on the keyboard, not the one on the keypad) to proceed.
4. When the HD Mount disk ejects, you'll see a floppy disk icon with a blinking question mark. "Hard Disk Mount" will be written under it.

From here on, the repair is the same as above. Insert the MacWorks System disk, and shortly thereafter, both the floppy disk icon and the hard disk icon will appear. Replace the System files and that's all there is to it.

Note: Hard Disk Mount is for repair purposes only. It's not an upgrade! Replacing regular Mac Works with Hard Disk Mount (using the Hard Disk Install Utility) is not recommended.



The third fix is to replace MacWorks XL with MacWorks Plus. MacWorks Plus provides full 128K ROM emulation, including the HFS file system, support for hard drives, support for SCSI drives, and it lets you use later versions of the Macintosh System and Finder. Install MacWorks Plus and you'll never see error code 0F0064 again.



MacWorks Plus

MacWorks Plus was developed by Sun Remarketing in full cooperation with Apple Computer. It's an official upgrade, supplied on disk, either 400K or 800K (you have to specify which) so you can use it with both the old and the new style 3.5-inch disk drives. As of version 1.0.18, the hard disk installer program required a megabyte of standard RAM (two 512K cards). If you have a memory upgrade, the upgraded card has to be in slot 2, and a stock 512K card has to be inserted in slot 1, or the installer won't run. The important point is, you need 1 Mb of memory and at least one 512K card to run the MacWorks Plus Installer program. So if you're planning to buy a memory upgrade, make sure you hang on to at least one of the original 512K cards!

What It Does

Other Macs contain two ROM (read only memory) chips packed with unique operating code. The Lisa doesn't. As soon as you turn on other Macs, portions of that code are read into RAM (random access memory). All Macintosh programs, including the System and Finder, rely on that code and presume it's going to be there. If it's not there, programs can't execute.

The MacWorks Plus Install program creates a file containing complete 128K ROM emulation on a read only portion of your diskette. Immediately after the automatic startup tests, that code is read into RAM by the Lisa's boot ROM. From that point forward, the Lisa is, for all intents and purposes, a big screen Macintosh Plus.

MacWorks Plus Hard Drive Installation

1. Since the installer program reformats (erases) the hard drive, an important preliminary step is to back up all important files. Skip old system files. MW+ 1.0. 18 requires new Macintosh System software (System 6.0 or later), so backing up System files is needless. After the backup, shut down normally and wait for the power light to go out.
2. Once the power light is out, wait 15 seconds or so for the internal hard drive to wind down (if appropriate) and turn on the Lisa. At the first click, tap any key but Caps Lock. Tapping a key will engage the Startup From menu as soon as the startup tests are done.
3. When the Startup From menu appears, insert the MW+ Boot disk and press Apple 2 to proceed.
4. As MacWorks Plus loads, a horizontal bar indicates progress. At the end, there's a beep followed by an icon of a floppy disk with a blinking question mark.
5. Assuming you have an icon of a floppy disk with a blinking question mark on the screen, insert the MW+ 400K System disk.
6. Once the desktop appears, eject the 400K System disk by choosing Eject from the File menu or by pressing Apple Shift 1.



7. Insert the MW+ Installer disk and wait for the disk icon to appear. Open the disk icon (if necessary) and then double click the MW+ installer icon. Swap disks as necessary until the program loads.
8. Follow the on-screen instructions to install MacWorks Plus onto your hard disk.
9. Reinsert the MW+ System disk. Drag the supplied System Folder to your hard disk.
10. Choose Shutdown from the Special menu.
11. Reboot. After the self-test finishes, you should see the Loading... indicator, then a MacWorks Plus sign on message. Next you'll be in the Finder.
12. Restore the hard disk. Be sure not to restore old System Files! MacWorks Plus 1.0.18 HyperCard 1.1, and MultiFinder 1.0 all require at least System 4.2 and Finder 6.0. Later versions may require even newer System software. The correct version was transferred in step nine. It's already been installed. Don't use a system higher than 6.03 with Macworks Plus Version 1.0.18.
13. Select the Chooser desk accessory from the DA menu. Select the correct printer and reset the printer port.
14. Select the Control Panel desk accessory to reset the time, mouse, and keyboard settings. Choose SunTrol to set contrast, screen dimming, and startup device.

Miscellaneous MacWorks Plus Information

Once installed, MacWorks Plus loads itself from the hard drive, then it usually boots the hard drive, but sometimes it shows you a floppy disk icon with a blinking question mark instead. When that happens, the Lisa is waiting for you to insert a Macintosh System/Finder disk. If you meant to start from the hard drive, press the right option key to proceed.

To reboot from a startup disk, hold down the Apple key and push the power switch. If you keep the Apple key down, you'll see the floppy disk icon with a blinking question mark. Insert a startup floppy disk, then let the Apple key up. The System file on the floppy disk (assuming it's version 4.2 or later) will now be in control of the computer. Once you get to the desktop, the floppy disk icon will be on top. The hard drive icon will be underneath.

Upgrading to MacWorks Plus may be all you need to do to bring an old Lisa/Mac XL up to the newest specifications. It's part of the 800K disk drive upgrade. It comes with internal hard drive upgrades, and it's available separately.

Loading MacWorks Plus on a SCSI Drive

MacWorks plus on a SCSI drive is somewhat different than explained above. MacWorks Plus does not reside on the hard drive. It must be booted from a floppy.



To load MacWorks Plus...

- 1) Insert the MacWorks Plus Boot disk into the floppy drive slot.
- 2) Turn on the computer and hold down the Apple key while typing a 2 during the memory test.

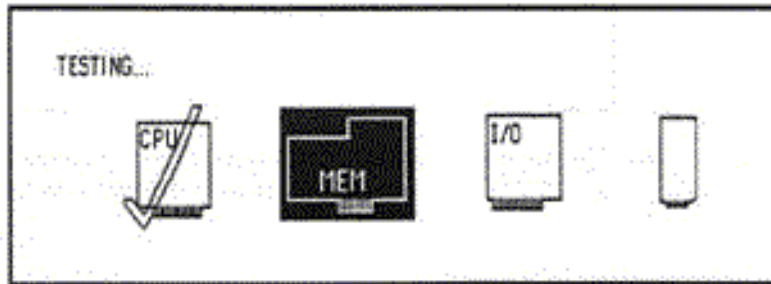

Then release. Be sure to type the 2 on the main keyboard and not on the 10-key pad. You will see the hourglass on the screen for a few minutes while the computer is working. The computer will run for a moment and the message "Loading...." will appear on the screen.

3) The Lisa system is now ready for a Macintosh Operating System. If an attached hard drive has a system folder on it (drives coming directly from Sun Remarketing will), the hard drive will automatically launch the system and finder. This will bring you up to the desktop with the Hard Disk icon in the upper right hand corner.

4) If you wish to bypass the automatic launch and boot with a Macintosh System disk or the MacWorks Plus Utilities Disk, hold down the left option key during the "Loading...." process and keep it held down until you get a diskette with a blinking question mark. Insert the Macintosh System disk or the MacWorks Plus Utilities Disk. This will bring you up to the desktop with the Diskette icon in the upper right hand corner, and you can proceed with your desired action.



800K Disk Drive Upgrade

The 800K disk drive upgrade includes a new 800K disk drive, exactly the same drive that comes in every other Mac, a new disk drive ROM chip, the latest Macintosh System software, and the latest version of MacWorks Plus. All you need is a #1 Phillips-head screwdriver to install the drive and a small flat-head screwdriver to install the ROM. Figure 27 shows an 800K drive installed in a Lisa 2/5.

Lisa 7/7 users may also take advantages of an 800K drive by using the Lisa Office System driver available from Sun Remarketing for \$15.

Here's the step by step 800K disk drive installation procedure:

1. Disconnect the computer's power cord from the wall outlet.
2. Remove the disk drive cage as shown in Figures 1 to 3.
3. Disconnect all data and power cables from the installed drives.
4. Remove the internal disk drive by tilting the drive cage forward. and loosening four Phillips-head screws at the bottom. Use a #1 Phillips-head screwdriver. Support the drive with one hand as shown in Figure 17.
5. Swap drives. Support the new drive the same way. Screw it into the exact same holes.
6. Reconnect the data cables. Replace the drive cage. Reattach the front cover.
7. Remove the rear panel as shown in Figure 4.
8. Refer to Figures 11 and 12. The disk drive controller chip is on the upper left corner of the board. The disk drive ROM chips are marked with white stickers. On a Lisa, the ROM to pull is part# 341-0290 at position A1. On an XL, its part# 341-0281 D at position A2. Carefully pry both ends of the chip with a small flathead screwdriver. Be sure to work from both ends. If you work from just one end, you'll bend and possibly break the pins.
9. Orient the new chip so that the notch is pointing upward. Make sure you use the right chip for your computer. Plug it into the socket. On a Lisa, the chip fits the socket perfectly. On a Macintosh XL, the socket is larger than the chip. Start from the bottom of the socket. The top of the socket is not used.
10. Replace the rear cover, reattach the power cord, and that's it.

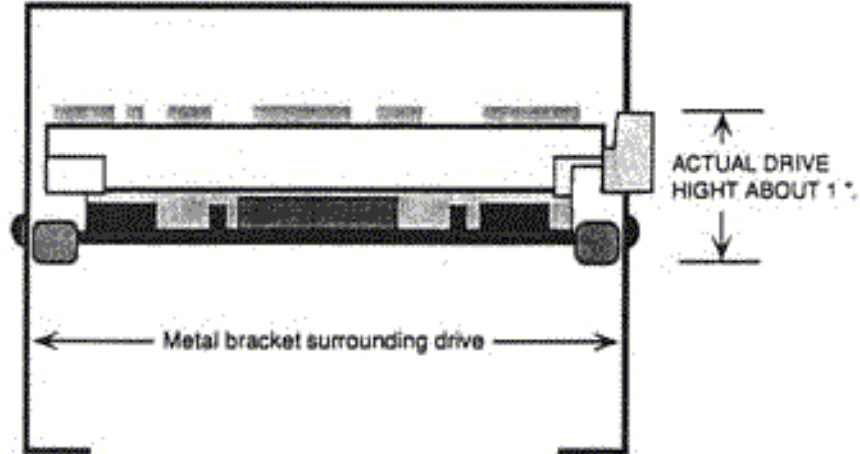

Figure 27

Profile view of an 800K drive in the mounting bracket. It takes up about half the room as a 400K drive.



Expansion Card Upgrades

The Lisa has three PC-like expansion slots to the left of the rear panel. Recently developed expansion cards simply plug into these slots. A SCSI card will allow you to connect up to 7 external SCSI devices. Together with an 800K disk drive upgrade, these cards essentially turn any 1Mb Lisa/XL into a big screen Macintosh Plus.

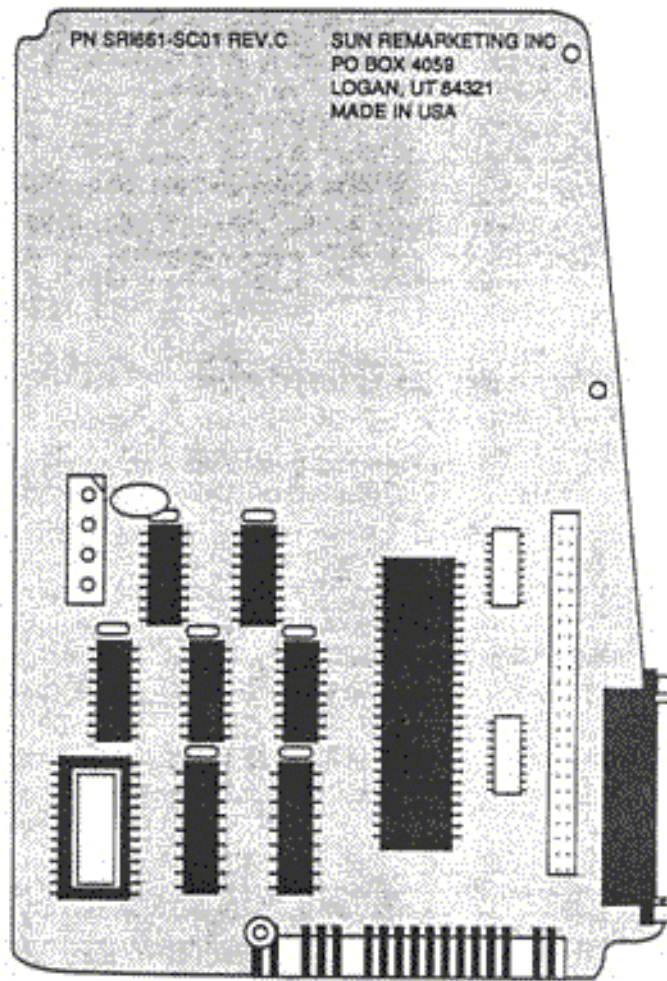

Figure 28
SCSI card for the Lisa/Mac XL.



Internal Hard Drive Upgrades

Through the years several hard drive options have been available. New technologies in both operating systems and the hard drives themselves make one option optimal, the Sun 40 SCSI. The Sun 40 SCSI is a true SCSI hard drive mounted on a SCSI card (see figure 30) that fits internally in the Lisa or Mac XL via one of the expansion ports. The SCSI card also allows you to connect external SCSI devices to your computer as well.

There are several reasons that this upgrade is so optimal. It uses the latest SCSI hard drive technology which offer greater speed and reliability. It also requires that you boot MacWorks Plus from a floppy. This small inconvenience allows the SCSI drive to be formatted 100% Macintosh. As a clean Macintosh drive you will be able to fix troubles using programs like Norton Utilities. Older hard drive options require that two environments exist on the hard drive. This made user repairs virtually unheard of.

*Lisa*

Computer Repair Information

Memory Upgrades

Early AST Ramstack upgrades (long since discontinued) took the Lisa/XL to 1.5Mb or 2.0Mb. RAM cards recently developed for the Lisa/XL use PC-style 256Kx9 single inline memory modules (SIMMS). Upgrading beyond 2Mb requires CPU board modifications as well.

Although the MC68000G8 process or can logically address 16 Mb, the original design of the Lisa/XL CPU board contains only enough physical address lines for 2Mb. By contrast, the 128K to 512K Mac CPU board contains just 0.5Mb of physical address lines, and the Mac Plus CPU board contains physical address lines for 4Mb. The necessary CPU board modifications add extra memory addresses, allowing you to populate the Lisa SIMM card all the way to 4Mb.



Lisa

Computer Repair Information

Video Upgrades-External Monitors

All Lisa/Mac XL computers are equipped with a, composite video out connector. As shown in Figure 28, the video connector is a standard RCA jack located just to the right of the reset button, at the rear of the computer. This connector accepts ordinary RCA phono cables, defined as shielded 2-conductor wire with an RCA phono plug on each end. Unlike the Macintosh 128K to Macintosh 11, it's not necessary to buy or build an add-on video card to use an external monitor on the Lisa/Mac XL. All you need is an external monitor with auto synchronous multiscanning capability and a matching composite video-in connector.



Video Upgrades-Internal Monitor Macintosh XL Screen Kit

No recently restored Lisa/Mac XL is complete without a Macintosh XL Screen Kit. Unlike the standard 9-inch Macintosh which has square pixels, the stock Lisa/XL has rectangular pixels. With rectangular pixels, circles look like footballs, squares look like spaghetti boxes. The purpose of the Macintosh XL Screen Kit is to square up the pixels. Proportions become exactly the same as on other Macs (1 to 1), but the overall display area (608 pixels x 432 pixels) is made roughly the same as a 12-inch Macintosh 11 WYSIWYG monitor (640 x 480). Standard 9-inch Macs only display 512 x 342 pixels.

The complete screen modification kit includes new 3A boot ROMs, a new video ROM and a new yoke coil. (Newer software requires System Update 5.0 and MacWorks Plus as well.) Conscientious installation of the complete screen kit requires one to two hours. This summary will give you an idea of everything that's involved:

1. If the set is on, power down normally and switch off the power.
2. Physically disconnect the power cord from the wall outlet. If you're the least bit hesitant about discharging the CRT, leave the set disconnected overnight. By the next morning, most, if not all, of the high-voltage charge will have dissipated.
3. Disconnect all peripheral cables, and remove the rear cover from the back of the computer. Refer to Figure 4.
4. Remove the card cage and the CPU board. Refer to Figures 9 to 10.
5. Remove the existing 20-pin video ROM from location C6 on the CPU board. Replace it with part number 341-0348.
6. Remove the 28-pin boot ROM from location D12 on the CPU board. Replace it with part number 341-0347.
7. Remove the boot ROM from location D 14. Replace it with part number 342-0346.
8. Replace the CPU board and put the card cage aside. Don't reinstall it just yet.
9. Remove the top cover. Refer to Figure 13.
10. Remove all rings, watches, and jewelry. Put on safety goggles.
11. With one hand behind your back, discharge the CRT through a 10-meg resistor.
12. Unplug the green and yellow CRT (yoke) to P2 cable from the video board. As illustrated in Figure 29, P2 is located approximately halfway down the left side of the board.

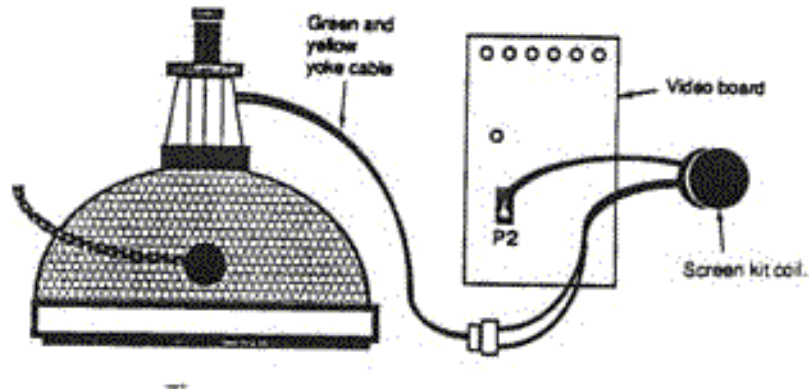

Figure 29
XL screen kit wiring details.

13. Plug the yoke cable into the new screen kit transformer. Plug the new transformer into P2.
14. The new transformer attaches to the outer wall of the disk drive chamber with double-sided tape. Clean the area, and attach the transformer as shown in Figure 30.
15. Locate the six adjustment potentiometers labeled "CONT.," "HOR. PHASE," "HEIGHT," "W. HOLD," "WIDTH," and "V. LIN" which are at the top of the video board. As shown in Figure 31, these adjustments have been sealed at the factory and will have to be unsealed and readjusted for use with the screen kit.
16. With a sharp razor knife, carefully remove all of the sealant * The key word here is all. It's not enough just to break the sealant. Any glob that remains may artificially limit the adjustment, making it impossible to properly realign the screen. For best results, every glob of sealant must be removed!
17. Refer to Figure 9. Slide the card cage back into the Lisa, and reconnect the power cord. Turn on the Lisa/XL.

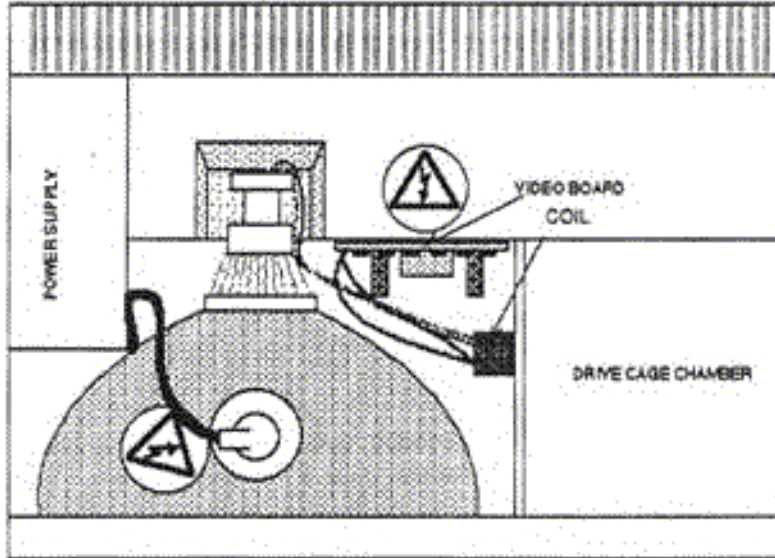

Figure 30

The new coil attaches to the outer wall of the disk-drive chamber with double-sided tape.

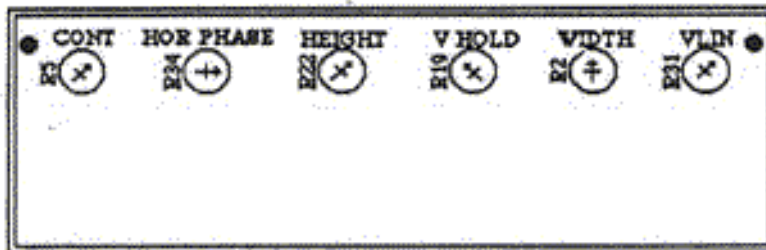

Figure 31

The CONT., HOR. PHASE, HEIGHT, V. HOLD, WIDTH, and V. LIN adjustments are at the top of the video board.

18. Adjust an accurate VOM meter to the lowest DC volt scale capable of measuring 5.0 V DC. Attach the black probe to the Lisa chassis. Locate the HOR. PHASE potentiometer, labeled R34, which is second from the left as you face the front of the video board. Turn around and face the rear of the video board. Find the point where R34 is soldered to the printed circuit. Insulate the red VOM probe with a piece of shrink tubing. Carefully touch the tip of the insulated, red probe to the rightmost of the potentiometer's three solder joints. (Note: if you do this while leaning over the front of the computer, the 5.0-V joint will be on your left.) Be careful not to short uninsulated probe tips to the steel card reading is out of range, go on to step 19. If it's in range, skip to step 21.

19. Refer to Figure 5. Turn off the Lisa/XL. Face the rear of the computer and unplug the power cord from the power supply. Unscrew the knurled knob and remove the supply by pulling straight back. New units may offer some resistance. Pull straight back.



20. As shown in Figure 32, find the access hole on the left side of the power supply. With a long-handled 1/8-inch slotted screwdriver, tweak the +5.00-V adjustment pot (R11) clockwise 1/16 of a turn. Reinsert the supply and measure again (repeating step 18). If the meter still doesn't read +5.00 volts, repeat steps 18 through 20 until it does.

21. The Macintosh XL Screen Kit generally causes horizontal foldover which manifests itself as an annoying 1/8-inch to 1/4-inch white bar at the left edge of the screen. Turn the horizontal phasing control (at the top of the video board) counterclockwise until it's gone. Properly adjusted, the pointer on the HOR. PHASE pot will typically indicate eleven o'clock. If you can't adjust the HOR. PHASE pointer past twelve o'clock, check for excess sealant and remove it as noted in step 16. If the pointer turns fully counterclockwise and you still have a foldover problem, check the +5.00 voltage adjustment as noted in steps 18-20.

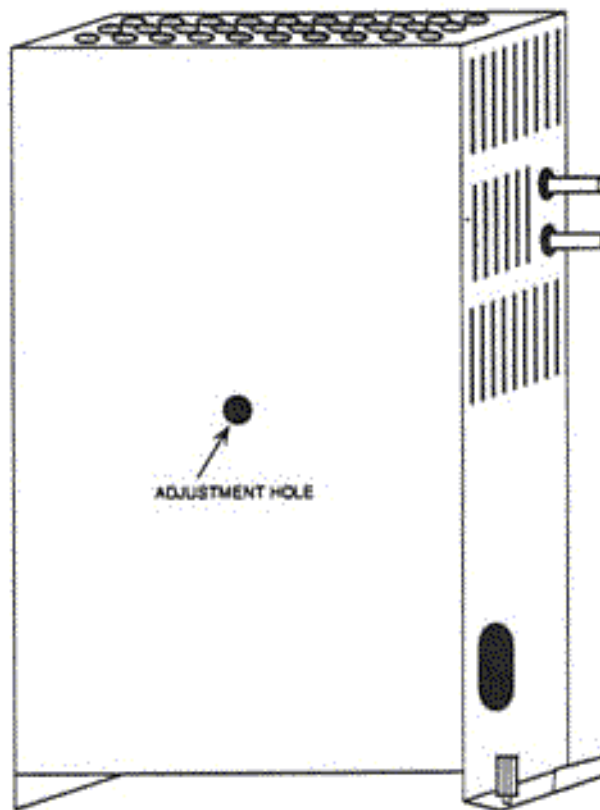

Figure 32

The +5.00-V adjustment can be reached through this access hole on the left side of the power supply.

The next step requires accuracy and involves the use of a soft cloth ruler (also known as a dressmaker's ruler). Use a good one. Because the edge protectors on cheap rulers are only haphazardly cemented to the tape, the first and last inches could be off by as much as 1/8 inch! Attempting the final alignment procedure with an inaccurate ruler will prove futile. Choose a quality cloth ruler. Check it carefully for accuracy before proceeding.



22. Boot MacWorks or MacWorks Plus. Measure the screen size. Don't be surprised if you have to turn both controls fully counterclockwise (to approximately 8 o'clock). The final raster should measure exactly 8.44 inches in width and 5.99 inches in height. If it's substantially larger than that, shut down the Lisa/XL and remove the power cord. Pull the card cage, observe the metal chassis and find the L3 (coarse width) access hole. As shown in Figure 33, L3 is located below the alignment pots and has to be tuned from the back side of the board. Insert a plastic hexagonal alignment tool through the access hole and turn L3 counterclockwise (in), one full turn. That should do it. Reinstall the card cage, reboot, and repeat the HEIGHT and WIDTH adjustments for best linearity.

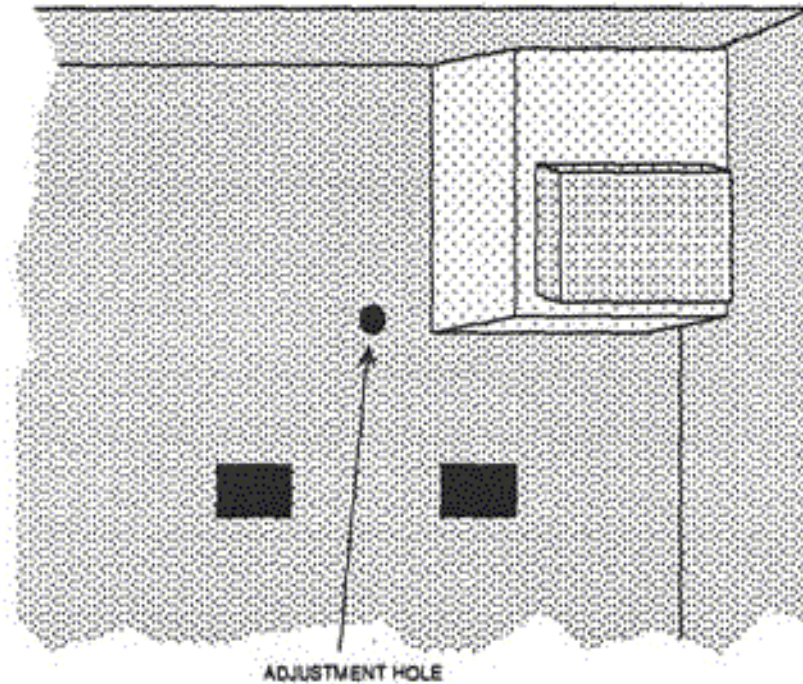

Figure 33

L3, the coarse width control, is located below the alignment pots and has to be tuned from the back side of the board.

23. With a draw or paint program try drawing true squares and circles. Circles should be nice and round and not egg shaped. squares should be square. The display should also be square to the frame. If any of these conditions exist continue with step 24. If not, skip to step 28.

24. If the raster is intolerably off -center or tilted, shut down the Lisa/XL and remove the power cord. Remove jewelry, put on goggles, etc., and discharge the picture tube again.

25. Refer to Figure 12. Remove the sealant from the purity rings at the neck of the CRT until both rings move freely.

26. Refer to Figure 9-2. In the event the raster was also tilted, loosen the yoke retainer as well,

*Lisa*

27. Plug in the Lisa and, while exercising all precautions, adjust the purity rings using just one hand, until the raster is centered on the screen. Next, adjust the yoke, if necessary, until the raster is square to the screen. With one hand still behind your back, carefully snug the yoke.

28. Complete the installation by relocking the adjustments to the PC board with fresh sealant.

29. Replace the top and the back cover. You now have a big screen WYSIWYG Macintosh display.

One final note, as mentioned earlier in this chapter, when the XL Screen Kit is used with the Lisa's light duty 1.2-A power supply (Apple Part# 6206103), audible transformer ringing may result, horizontal retrace lines may become noticeable, and a slight screen flicker may be introduced. The fix is to install the Lisa's heavy-duty 1.8-A power supply (Apple Part# 699-0189).



Summary

Despite the implication, an XL Screen Kit is not something you buy to turn a Lisa into a Mac XL. It's something you buy to turn Lisas and Mac XL's into WYSIWYG big-screen Macintoshes. Combined with an 800K disk drive upgrade, the result is a big-screen 1024K Macintosh. Combined with a SCSI card, the result is a big-screen Macintosh Plus. Combined with an internal hard drive, the result is a big-screen Macintosh SE. Add on an accelerator card, and what you've got is somewhere between a Macintosh SE and the

Macintosh II.

Consider the similarities: All three computers have detachable, dual voltage, heavy-duty power supplies. All three computers accept internal hard drives. All three have built-in expansion slots. All three have internal boxer fans. All three have heavy-duty keyboards with integral numeric keypads. The Macintosh II is regularly matched to a 12-inch monochrome display. The Lisa/Mac XL is permanently matched to a 12-inch monochrome display. You could almost say that the philosophy has come full circle.



Appendix A-General Trouble Shooting

- | | |
|---|---|
| No Power. | a) Front or back cover not seated tightly (pg. 5)
b) Power supply fuse needs to be replaced (pg. 7)
c) Bad Power Supply (pg.5)
d) Bad outlet |
| Power flicks briefly then cuts out. | a) Bad Power Supply (pg. 5)
b) Bad Video Board (pg. 41)
c) Bad Soft Switch (on/off button) |
| Screen goes blank & computer stays on. | a) Bad Video Board (pg. 41)
b) Bad Screen Mod Coil (pg. 43)
c) Bad Video State ROM (pg. 10) |
| Video jumps, rolls or flickers on the screen. | a) Video board needs adjusting. (pg. 44)
b) Power supply needs adjusting (pg. 45) |
| "Continue or start up" from message when trying to boot up. | a) Check error codes on pg. 16 |
| Restarts after "Welcome to Macintosh" screen | a) Bad system folder (boot from floppy and replace the system folder)
b) Use FIND FILE to search for a second system icon and remove.
c) Using 512k memory with MacWorks Plus |
| Screen shakes with "Welcome to Macintosh" start up screen. | a) Bad system folder (boot from floppy and replace the system folder)
b) Use FIND FILE to search for a second system icon and remove. |



- Sad Mac error with black screen. a) Bad system folder. (pg.32)
- Screen is not displaying characters the way they are printing out. a) Need to install the Screen Mod Kit (pg.41)
- Hard disk is not being recognized. a) Reinstall Macworks X/L, MW Plus or Lisa Office.
b) Disconnect hd cables and reconnect.
c) check for brake problem on 10mb drives. (pg. 29)
d) Return drive to Sun Remarketing for factory format.
e) If using an SCSI drive, slide the card back and in the slot to reseal the card.
- 400k floppy drive problems a) Refer to pg. 22
- 800k Drive reading extremely slow. a) Replace the 800k drive chip on the I/O board.
- 800k Drive continually ejects diskettes a) Pull test pins 9 and 20. Count from top to bottom starting right to left. Pin one upper right hand corner. Pin 3 is just to the left of pin one.
- Apple Talk problems a) Cut resister on R38 and scratch trace on chip1489 right hand side third trace down. (Only on the Lisa I/O not on Mac XL I/O)
- Batteries on I/O board are corroded. a) Remove batteries. Computer will draw power from the outlet to run the clock when plugged in.
- Printer not printing. a) Check Chooser. Port A = modem port. Port B = Printer
b) Cable should be a modem cable with a modem eliminator cable.
- Printer Prints 1/2 of the page then prints garbage. a) Handshaking problem. Lisa requires hardware handshaking. (Imagewriter SW 2-3)
- Printer shuts down during printing. a) Macworks Plus bug. Obtain a new copy of the Macworks Plus program.
- Error appearing on screen during shutdown a) Macworks Plus bug. Will not effect functionality of the computer or cause any loss of data.

THE END / 01 Sep 1998